

Rev. no.	Description	Apply from	By	Checked
 kvillsfors fönster 570 16 Kvillsfors Tel. 0383-197 00 Fax. 197 29 www.kvillsforsfonster.se		FÖNSTER TYP KT390		
Drawn by	Date	Rev. date	Scale	Drawing No.
UK.	06-02-21		1:2	KT390:1

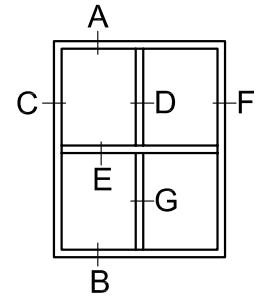
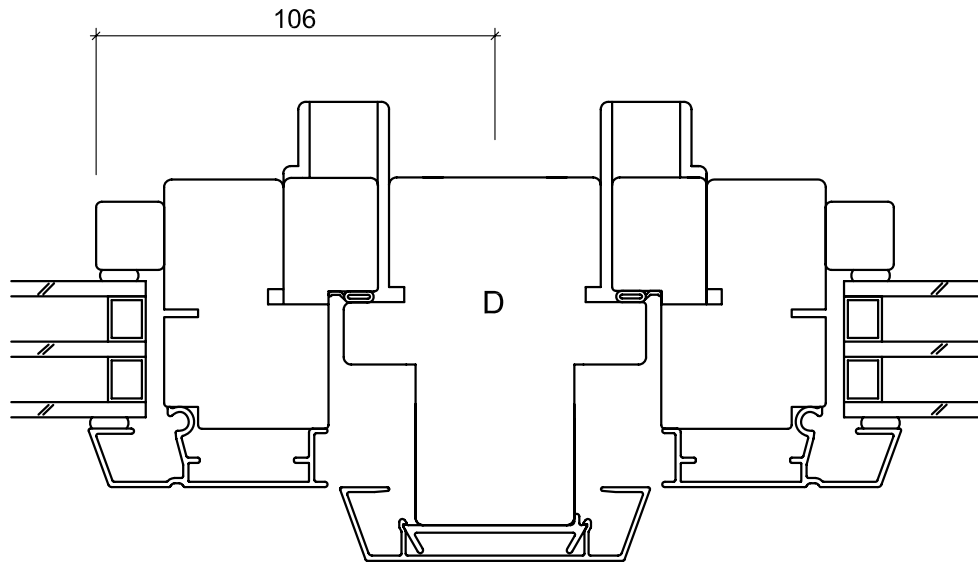
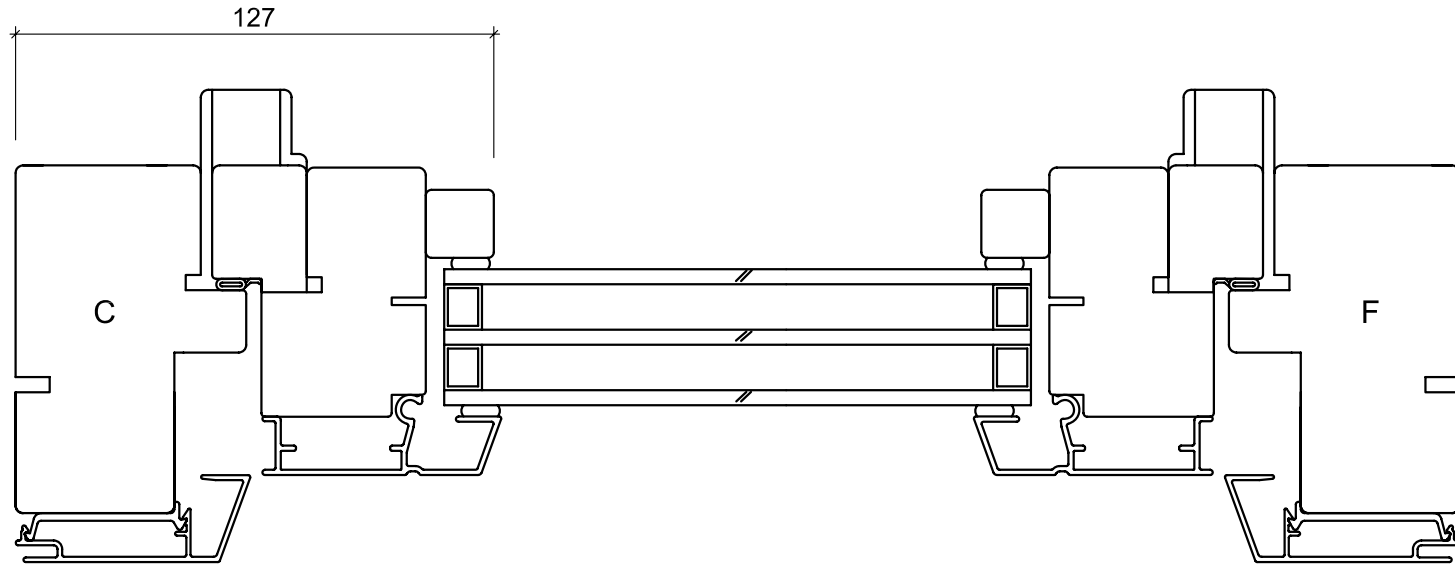

100
90
80
70
60
50
40
30
20
10

Rev. no.	Description	Apply from	By	Checked
 kvillsfors fönster 570 16 Kvillsfors Tel. 0383-197 00 Fax. 197 29 www.kvillsforsfonster.se		FÖNSTER TYP KT390		
Drawn by	Date	Rev. date	Scale	Drawing No.
UK.	06-02-21		1:2	KT390:2

EX. PÅ KOMBINATIONER

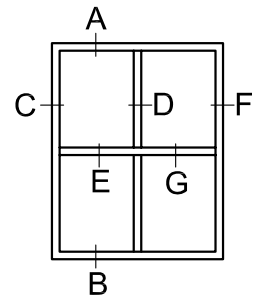
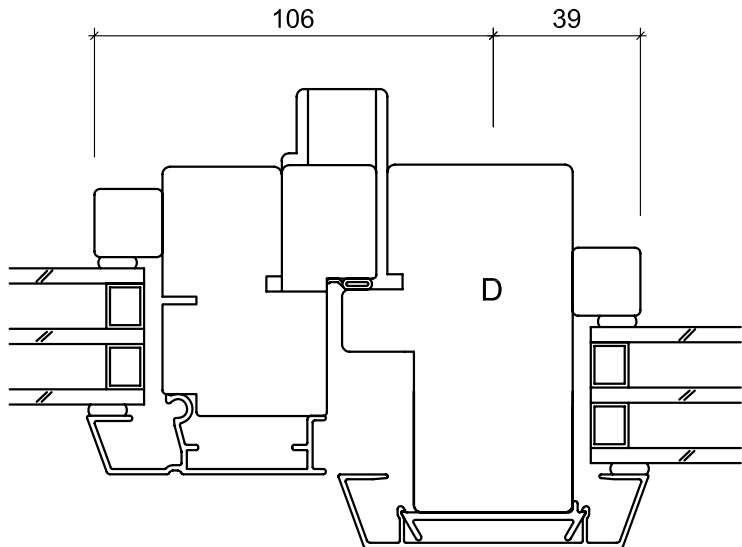
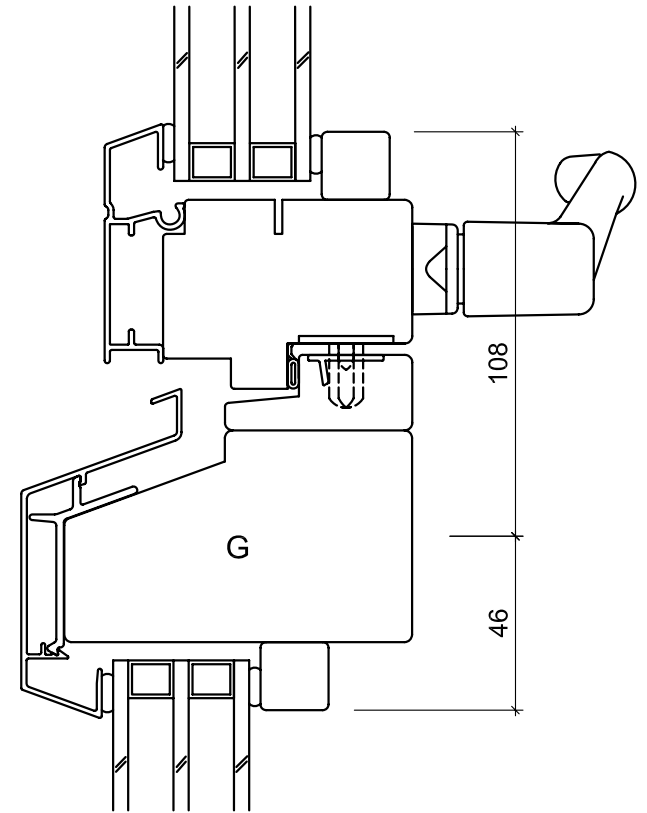
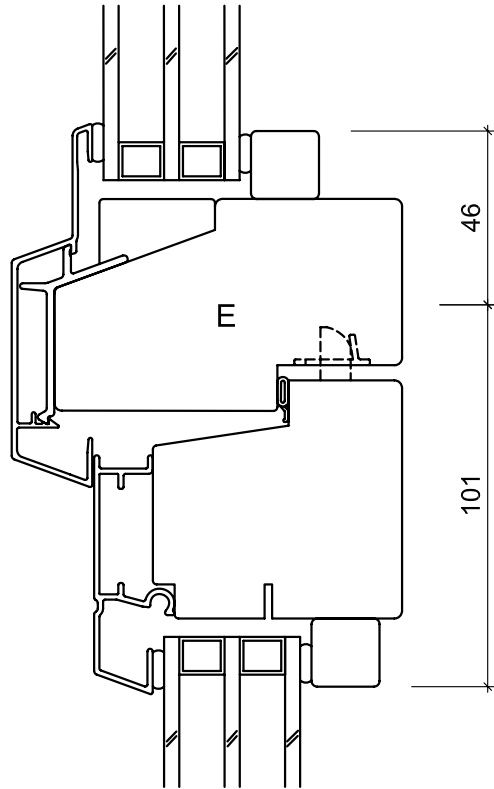

100
90
80
70
60
50
40
30
20
10

Rev. no.	Description	Apply from	By	Checked
 kvillsfors fönster 570 16 Kvillsfors Tel. 0383-197 00 Fax. 197 29 www.kvillsforsfonster.se		KOMB. FÖNSTER TYP KT390		
Drawn by	Date	Rev. date	Scale	Drawing No.
UK.	06-02-21		1:2	KT390:10