

Allmogeprofil  
Utvändigt

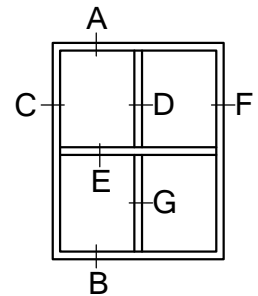

100  
90  
80  
70  
60  
50  
50  
40  
30  
20  
10

A	Utvändig allmogeprofil tillkommit.	2009-06-23	TE.	
Rev. no.	Description	Apply from	By	Checked

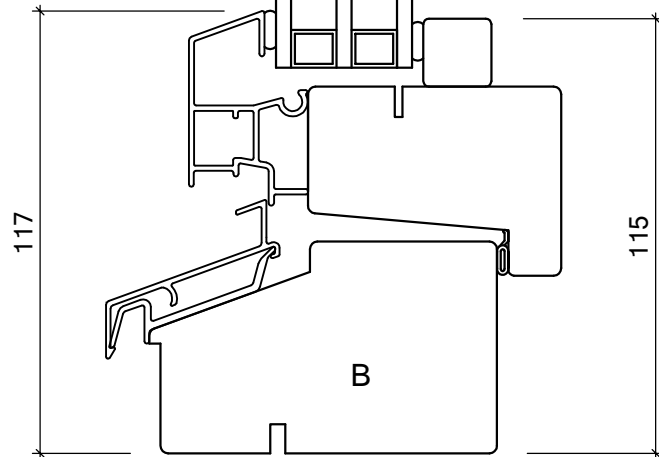
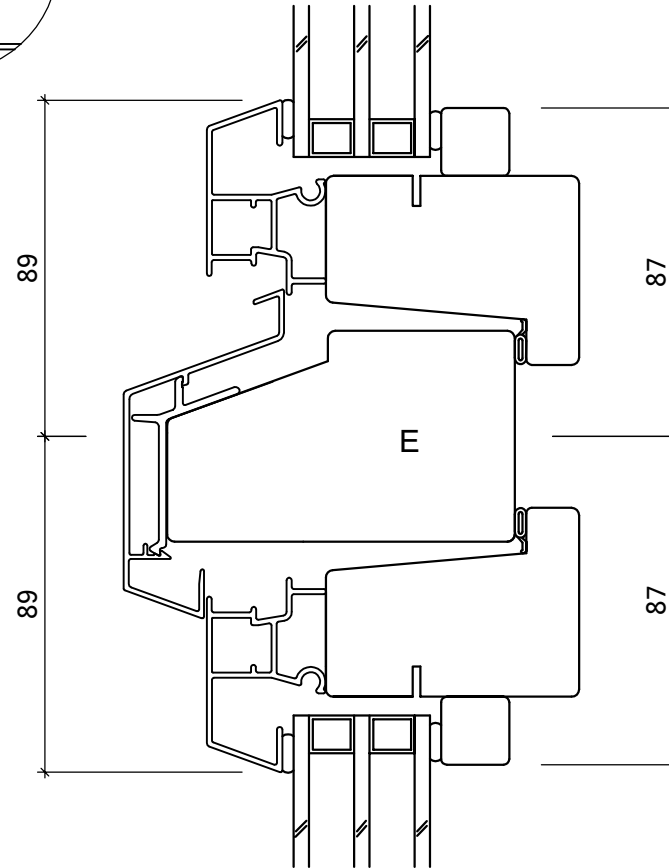
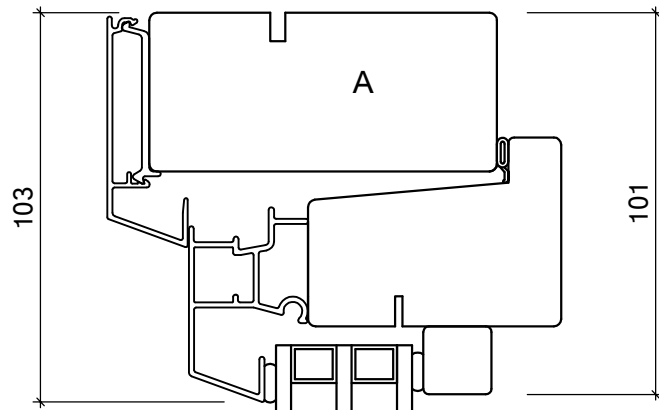
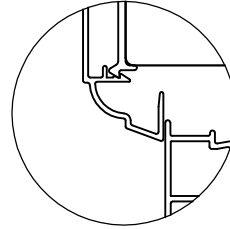

**kvillsfors fönster**

570 16 Kvillsfors  
Tel. 0383-197 00 Fax. 197 29 www.kvillsforsfonster.se

FÖNSTER TYP KT191

Drawn by	Date	Rev. date	Scale
TK	02 01 12		1:2

Drawing No.

**KT1Q1-1**

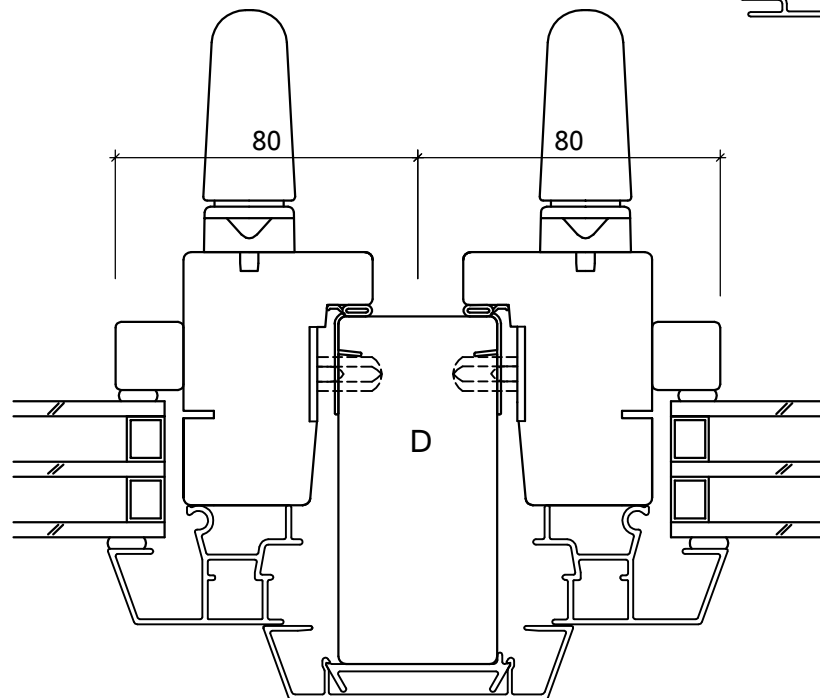
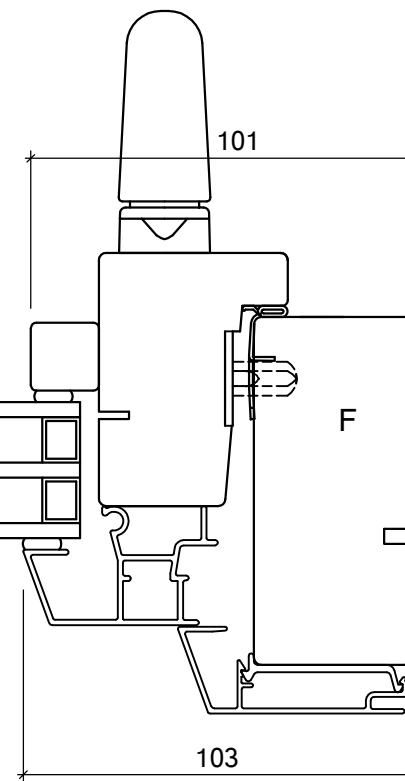
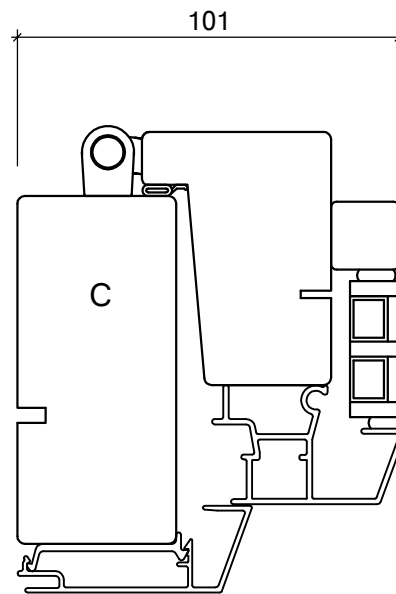
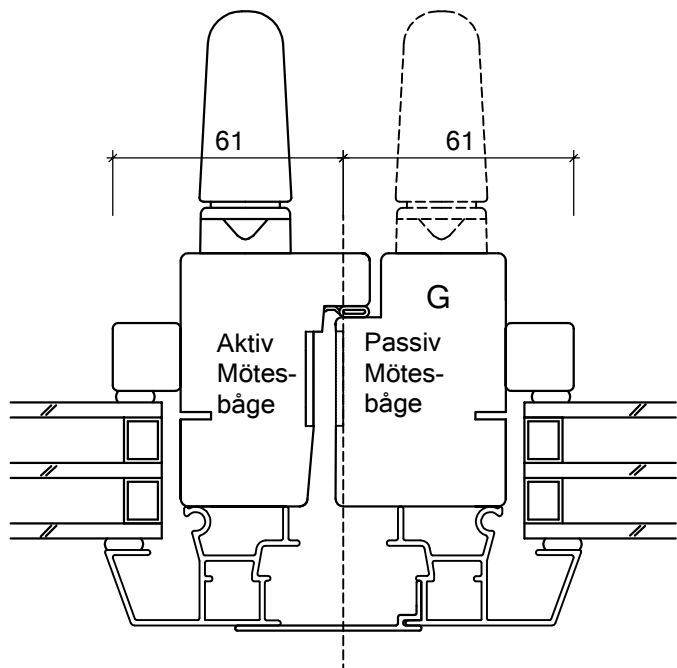

Allmogeprofil  
Utvändigt

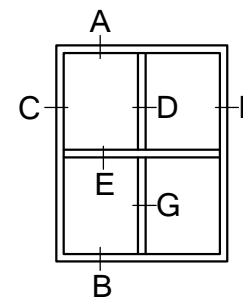
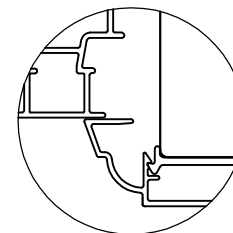

100  
90  
80  
70  
60  
50  
40  
30  
20  
10

A	Utvändig allmogeprofil tillkommit.	09-06-23	TE.	
Rev. no.	Description	Apply from	By	Checked
 <b>kvillsfors fönster</b> 570 16 Kvillsfors Tel. 0383-197 00 Fax. 197 29 www.kvillsforsfonster.se		FÖNSTER TYP KT191		
Drawn by	Date	Rev. date	Scale	Drawing No.
TK	02-01-12		1:2	KT1Q1-2

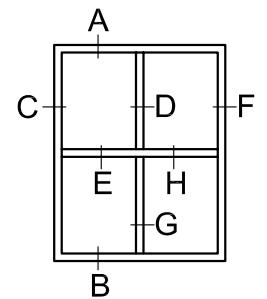
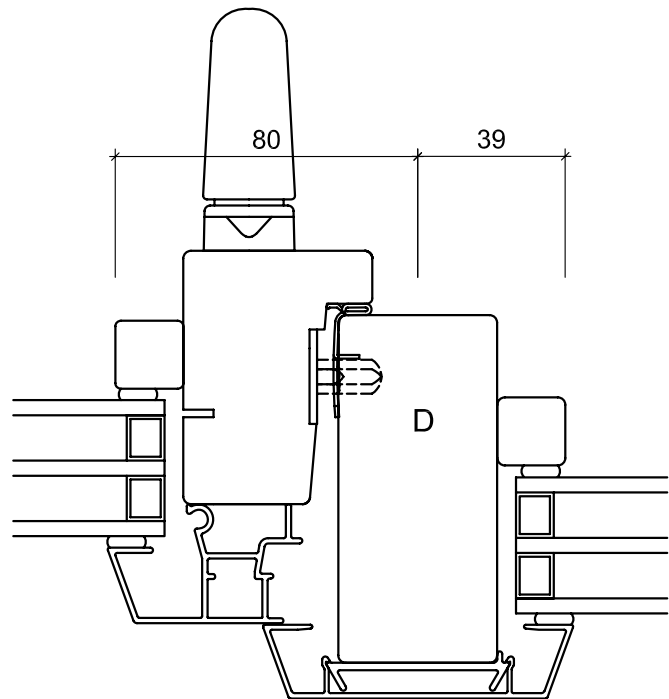
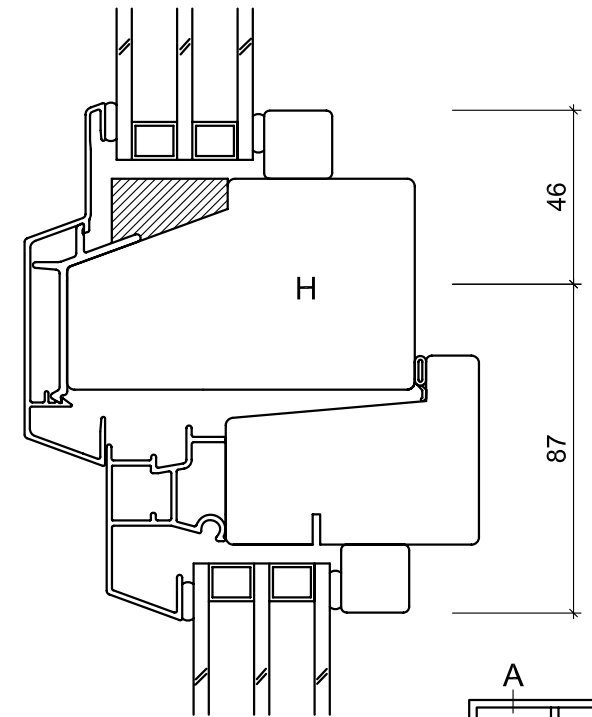
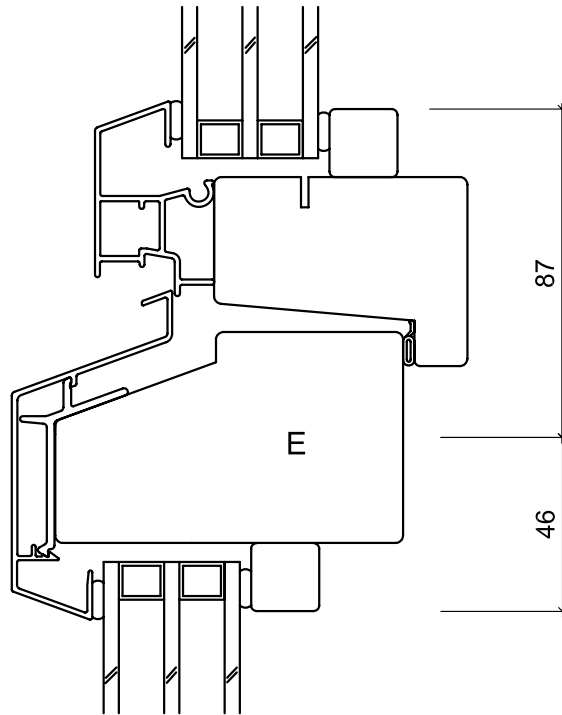
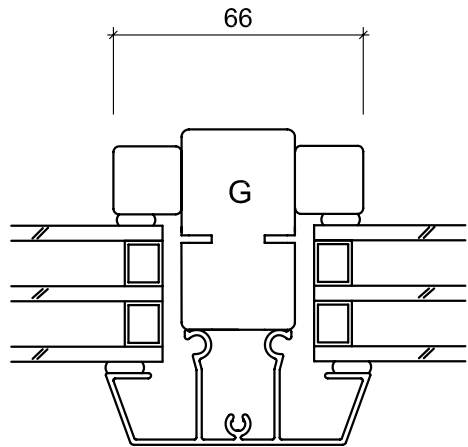

EX. PÅ KOMBINATIONER

Rev. no.	Description	Apply from	By	Checked
 <b>kvillsfors fönster</b> 570 16 Kvillsfors Tel. 0383-197 00 Fax. 197 29 www.kvillsforsfonster.se		FÖNSTER TYP KT191		
Drawn by	Date	Rev. date	Scale	Drawing No.
UK.	03-01-12		1:2	KT191:10